

ITEM NO.	PART NUMBER	DESCRIPTION	QTY.
1	TTC370QA036	REACTION ARM	1
2	HLC006PM001	HANDLE	1
3	TTC370AS002	PLUG	1
4	TTC370JS004	LATCH PIN	1
5	TTC370KS002	SPLINE SLEEVE	1
6	SPC018CB001	SPRING	1
7	TTC370ES003	SLEEVE	1
8	TTC370US001	LOCK RING	1
9	TTB06	TOMMY BAR	1

REVISION

1 6365

2

3

4

5

6

7

8

9

10

11

12

13

14

15

16

17

18

19

20

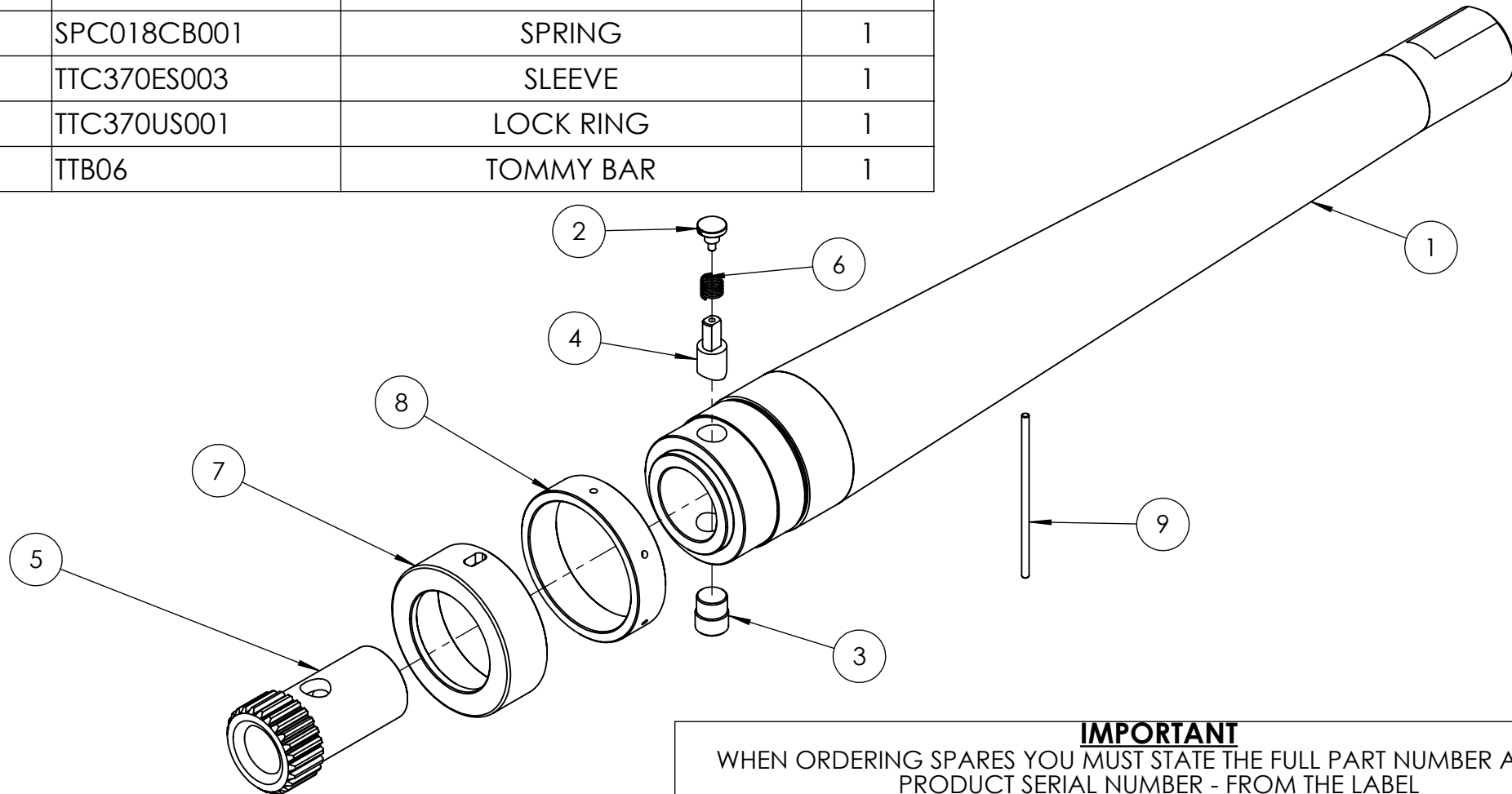

IMPORTANT

WHEN ORDERING SPARES YOU MUST STATE THE FULL PART NUMBER AND THE PRODUCT SERIAL NUMBER - FROM THE LABEL TO PROTECT YOUR WARRANTY ALWAYS USE GENUINE HI-FORCE PARTS.